

Start-up + Operation

Electronic pneumatic tank measurement system of the **e-litro®** series

e-litro	SW-Version V6.0x
e-litro secu4	SW-Version V6.0x
e-litro net	SW-Version V6.0x
e-litro gsm	SW-Version V6.0x

for tank sizes up to max. 10,000 liters

<u>CONTENT:</u>	Installation and mounting	4
	Control elements and display	4
	ALARM and QUIT-button for secu4	6
	Device setup and programming	7
	Programming examples	10
	Tank with interior mantle	11
	Special settings	12
	Error messages / Error indication	14
	- for device type e-litro net	15
	- for device type e-litro gsm	17
	Electrical connections	18
	Regualtions and maintenance	20



Installation and mounting

E-litro devices are not viable for external installation (safety class IP50).

The tank monitoring system is no overflow safety.



During the tank filling the **secu4** assists to avoid an overflowing after TRwS 791. It will report a filling limit ALARM to interrupt the current loop of the limit indicator and disable the tank filling.

The **secu4** does not replace but support the limit indicator by monitoring the downstream battery tanks.



For installation and mounting of the devices mentioned above please follow the conditions of the respective manual. The corresponding safety instructions for electric devices and oil tanks need to be observed.

The startup is performed after successful mounting.

The displaying devices of the **e-litro®** series are applicable for liquid level measurements of tanks operated unpressurized. **Maximum display value: 10,000 liters** (per tank, in case of **secu4**)

The liquid level is indicated by the LCD display. The instrument versions **e-litro net** and **e-litro gsm** are able to retransmit the displayed data and the present status (data transfer via RDT). The devices of the **e-litro** series are equipped with a power plug for 230V sockets.

The transducer (sensor) is connected to the measuring input of the **e-litro** displaying device. Usually the transducer is the electronic-pneumatically measuring LITRO-Sensor: A level measurement sensor with a measurement range of 0-25 kPa (0-250 mbar) for relative hydrostatic pressure.

Measuring input: 4-20 mA analog signal, 2-wire principle with sensor supply of 20V dc.
clamp 1 = plus, white (or red)
clamp 2 = minus, brown (or black)

Other transducers with 4-20 mA signal could also be connected to the **e-litro** displaying devices (except for **secu4**).

CONCEPT:

e-litro / e-litro net / e-litro gsm
with LITRO-sensor

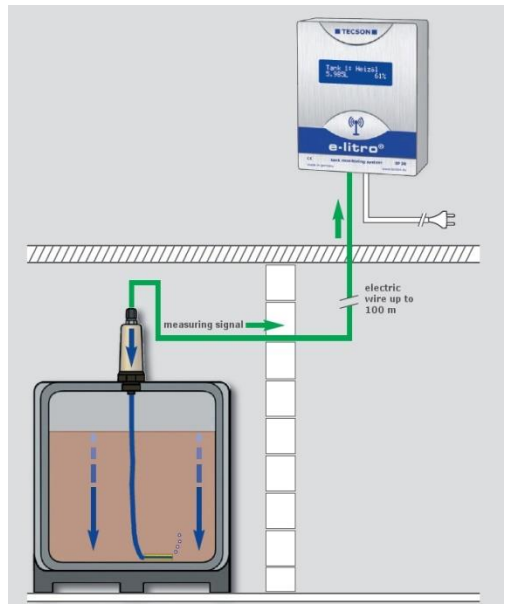

e-litro secu4:

The **secu4** device is an oil tank measuring system for battery tank systems. The complete set consists of the displaying device and the sensorbox which has to be mounted close to the tank.

The sensorbox of the **secu4** has 4 measuring hose inputs to measure and observe 4 single tanks of one tank-battery at the same time. In addition to the level indication (in liters, cm, %, refillable clearance) the device also monitors the levels of every single tank to avoid an overfilling. If during the tank filling the level of one of the tanks reaches its maximum, e.g. 95% filling limit, the **secu4** will sound the ALARM and an output relay will interrupt the current loop of the tanker.

The displaying device and the sensorbox both contain of an alarm sound.
Such an alarm can be switched off by pushing the QUIT-button on top of the displaying device.
In case of an alarm the QUIT-button will flash red.

Instead of connecting it to a 4-20mA sensor as usual the **secu4** has to be connected to the sensorbox via three-pole clamping block on the left hand side of the circuit board:

secu4 data input from the sensorbox:

clamp 1 = plus, **white** (or red)
clamp 2 = data, **green** (or blue)
clamp 3 = minus, **brown** (or black)

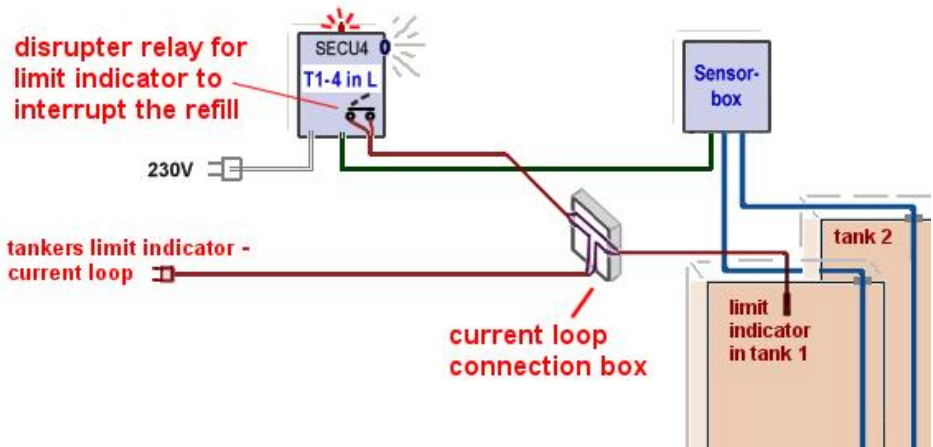

The data line from the sensorbox to the displaying device (three-pole) is prolongable up to 50m

The use of a current loop connection box is optional. Therewith the tank filling can be interrupted automatically.

Control elements and display

First determine the container data and then enter the data into the device menu. The programming is described in the following pages.

To setup the displaying device the lid has to be twisted off. Perform the device setup once at the initial startup. After startup the device operates in displaying mode while the lid is closed.

By pressing the [Enter] button the displaying mode changes to menu mode. With menu item €xitq (step 0 or 7 or 8) the programming mode is left and the normal displaying mode is active.

Display panel

2 x 16 characters are displayed in a two-line LCD display. The display is equipped with a background lightning for best readability at all lightning conditions.

Control keys

For device setup use the 3 little pushbuttons (blue or pink) located on the electronic base plate: [+] [Enter] [-]

Enter = Confirm selection. **+/-** = Change values or skip to next menu step.

Language

Select the operation language (German / English / French) in menu step 18.

Select displaying mode for **e-litro** and **e-litro net /gsm**:

After setting menu items 1 to 5b the favored displaying mode is to be selected under menu item € . Display

The name of the tank/liquid is shown on the left hand side in the top line and is adjustable under menu item ø8 . Language + Namesq

In in the second line of the display it is to be selected to either show the refillable clearance (up to limit indicator) and/or the percentage (inventory) and/or the current liquid level in cm.

Settings: 6. Display:

Line 1: Name + Inventory in (-) L:

Line 2: Fillspace in (-) L + Vol.percentage:
(bottom left) (bottom right)

Line 2: Fillspace in (-) L + Liquid level:

Line 2: Vol.percentage + Liquid level:

Heat. oil	6.200 L
- 3.550L	65 %

Heat. oil	6.200 L
- 3.550L	104cm

Motor oil	6.200 L
65 %	104cm

RECOMMENDATION:

Make sure the refillable clearance (fillspace) is always shown.

While refilling the tank the clearance needs to be detectable! (In accordance with TRwS 791)

Additional benefit: In Example 1 and 2 the bottom left value €x.xxxL shows the present heating oil consumption if previously the tank had been filled up to the filling limit.

Display of the e-litro secu4:

The menu item 6. Displayqis without a functionqand therefore not available.

In case of a battery tank system the device is able to observe and show the values of 1 to 4 tanks in the four display lines.

Additional to the usual displaying of the current liquid volume the clearance is shown before and during the refilling process (In accordance with TRwS 791).

The clearance is the value (in L) that is left until one of the single tanks reaches the selected filling limit (of e.g. 95%) during a parallel filling.

Under menu item 5b the filling limit is to be adjusted to the limit indicator height as accurate as possible.

Password:

The device settings can be protected by activating a password under menu item 8.

A forgotten password can be requested by contacting TECSON.

Resetting the **secu4** will cause the device to demote in a non programmed state

secu4 display with 1 or 2 tanks:

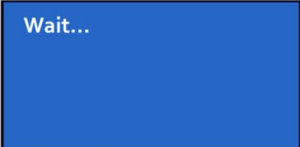
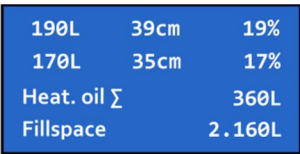
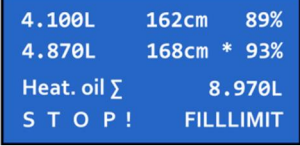
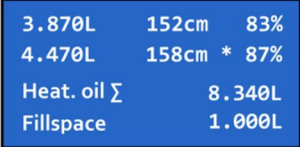
<p>DISPLAY: wait...q The displaying device waits for stable measurement data from the sensorbox. This can last 1 . 3 min. after turning on the device.</p>	
<p>DISPLAY: Values tank 1: Values tank 2: Inventory sum: Fillspace: No displaying switch occurs. Line 3 and 4 show inventory and fillspace.</p>	
<p>While refilling the inventory is measured and displayed as well. As soon as one of the tanks reaches e.g. 93% the display changes line 4 to STOP! FILLLIMIT.</p>	
<p>During the daily removal processes of the liquid later on line 4 will change itself into a consumption indicator. This consumption indicator shows the liter-consumption since the last complete refill.</p>	

secu4 display with 3 or 4 tanks:

Regular display:

In case of a battery tank system with 3 or 4 tanks the display will switch over. Thereby the single tank display and the inventory and clearance display are shown alternately.

[1] 990L 39cm 22%	Switch-over =>	[1] Heat. oil Σ
[2] 970L 35cm 17%		[2]
[3] 990L 39cm 22%		[3] Invent. 3.090L
[4] 1.040L 43cm 26%		[4] Fillspace 6.410L

If while refilling one of the tanks reaches 93% a **STAR** as well as the warning **STOP! Filllimit** will appear.





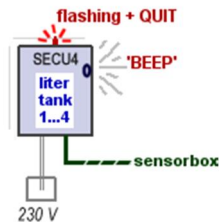





[1] 8.970L 138cm 91%	Switch-over =>	[1] S T O P ! FILLLIMIT
[2] 8.910L 135cm 89%		[2]
[3] 8.980L 138cm 91%		[3] Invent. 35.960L
[4] 9.100L 142cm * 94%		[4] Fillspace 600L

ALARM and QUIT-button for secu4:

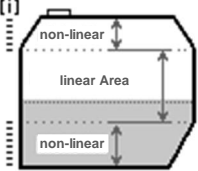

Reference in this case is 95% filling limit, i.e. signaling at 93%

Filling level / action	Status	Red LED (Quit-button)	Beeper (loud)	Relay break contact	Display
all levels below limit	OK	off	off	closed	OK
level >= 93 % at refill or reserve	warning	flashes	double beeping	closed	STOP
Quit-button, shortly (quit beeper)	warning gets quitted	turns off	turns off	closed	STOP
level reaches 95% (limit)	alarm	flashes	fast double beeping	disrupts	STOP
Quit-button, shortly (quit beeper)	alarm gets quitted	flashes	turns off	stays disrupted	STOP
Quit-button, long hold for 3 sec. (quit beeper)	Quit-status but level still exceeded	changes to continuous light	off	closes again	STOP
level drops under 94% (thru consumption)	warning	turns off	off	closed	full (stop)
level drops under 92%	OK	off	off	closed	OK

3. Tank shape	Selection of tank shape: Alternatively just 1 special tank geometry can be setup by a <u>Bearing chart</u> for liter conversion.	all
	Linear Default: <u>Linear</u> tank. Rectangular tank/ vertical cylinder/ steel cellar tank.	
Cylindric horiz	<u>Cylindric</u> tank. Horizontal cylinder/ tubular container. Typical tank shape for outdoor tanks and buried steel tanks.	
Ball-shaped	<u>Spherical</u> tank. Ball-shaped buried tank. Common buried plastic tanks (GRP).	
Oval	<u>Oval</u> cellar tank. Typical shape of GRP plastic tanks.	
Convex	<u>Convex</u> plastic tank, mostly as a battery. Slightly bellied tank shape.	
Concave	<u>Concave</u> plastic tank, mostly as a battery. Concaved tank shape.	
With excavation	Plastic tank with large cavity. Excavation in the middle of the tank's body. (No ring bandages)	
Cyl. > 50m ³	Not applicable with e-litro displaying devices.	
Bearing chart Value input by an existing bearing chart of the tank	<u>Reference table</u> : Basic value table with up to 15 pairs of values $\mu\text{m} \Rightarrow \text{liter}$ for the non-linear areas of the tank. Step 4 (Tank volume) and Step 5 (Tank height) have to be set up beforehand. Value pairs for 0% (0.0 cm \Rightarrow 0 L) and 100% (tank height \Rightarrow volume) are already set and do not have to be entered again. Index [1] xxx.x cm \Rightarrow xxxx L Index [2] cm \Rightarrow L Index [n] cm \Rightarrow L Non-linear area: Enter several value pairs. Linear region: Enter only begin and end pairs.	Unsymmetrical or other tank shape (i)  Individual tank shape
Steel tanks	<u>Steel tank</u> or <u>battery tank group</u> : Linear side panels, with <u>hemicycles</u> at top and bottom.	

<u>Input function:</u> <u>Menu functions</u>	<u>Description</u>	<u>Device type</u>
<p>4. Tank volume</p> <p>Enter the tank's volume by [+] [-]. (100% value) Default is 0 L. This value <u>must</u> be entered.</p> <p><u>Attention, in case of an existing bearing chart:</u> Please use the pair of values for 100% for tank volume and tank height from the table. For a 10m³ buried tank values may be e.g. 10,250 l and 198.5 cm.</p> <p><u>For the secu4</u> the total volume of a single tank has to be set. Display: e.g. 3 x 1000 liters</p> <p>Set the <u>minimum limit</u> as a %-value. If the level comes below the minimum limit the device will sound an acoustic alarm. 0% = feature off / 50% = max value</p> <p><u>For secu4</u> 4b. Minimum limit</p>	<p>maximum volume: 10,000 L</p> <p><u>only for secu4</u></p> <p>Cancel alarm via Quit-button</p>	
<p>5. Tank height</p> <p>Enter the interior height of the tank in cm: e.g. 249.0 cm <u>Attention:</u> If a bearing chart is available it is recommended to take the max. value pair out of the chart. For a 10 m³ buried tank with d = 2 m a potential value could be 198.7 cm.</p> <p>Set the filling limit of the tank here: For oil tanks this will represent the switch-off point of the limit indicator. The preset is 95%. e.g. Filling limit: 95%=190cm change of value with + / - . If e.g. a water tank may be filled to capacity the filling limit is to be set to a value of 99%.</p> <p>5b. Filling limit</p>	<p>all</p> <p>all</p>	
<p>6. Display</p> <p>The upper display line shows the name of the tank und the inventory in liters (for other units see menu item 12).</p> <p>Set the displaying mode for the second display line here: View details: Fillspace+Percnt (-L, %) or Fillspace+Level (-L, cm) or Percent+Level (% , cm)</p> <p><u>resp. for secu4 without function</u></p>	<p>For heating oil tanks option 1 or 2 is recommended (according to TRwS 791-2 the clearance needs to be displayed).</p>	<p>e-litro gsm e-litro net</p> <p>irrelevant for <u>secu4</u></p>
<p>7. Relay</p> <p>Switching function of relay 1: <u>deactive</u> / active / on / off</p> <ul style="list-style-type: none"> - deactive Effect: Relay operates independently of the content. In addition there is no remote signaling of the relay state. - active Effect: Relay operates depending on the content. - on Makes the relay energize (fix ON). - off Makes the relay release (fix OFF). <p>Example <u>switching point setup for active</u>(with hysteresis):</p> <ul style="list-style-type: none"> On 10% - Enter relay's energizing point by + / - Off 15% - Enter relay's releasing point by + / - <p>If both values are set to 0% the relay switching function is disabled.</p> <p><u>For secu4:</u> Preset: - opener (tanker off) = limit indicator-disrupter - closer (<u>only</u> for other switching functions!)</p> <p>The relay switching point is the %-limit from menu item 5b.</p>		<p>e-litro gsm + e-litro net</p> <p><u>secu4:</u> for limit indicator-disruption</p>

<p>8. Exit or 8. Password+Exit</p> <p>secu4 password activation:</p>	<p>Press [Enter] to leave the setup mode (parameterization).</p> <p>For the secu4 the password protection needs to be activated with \pmESq if the relay disruptor function for the overfill safety is used.</p> <p>During the activation the password will be shown once. The password is fixed, meaning it is not changeable but <u>only activatable/deactivatable</u>.</p> <p>The qualified technician should note down the password and store it appropriately. If the password is lost please contact TECSON. Therefore please have the <u>serial number</u> of the device ready!</p>	<p>not for secu4</p> <p>for <u>secu4</u></p> <p>loss of password</p>
<p>Menu item 9 Æ 24</p> <p>see ff.</p>	<p>Steps 9 . 24 contain special settings which usually will not be needed.</p>	<p>all</p>

After entering/setup of step 1 to 7 the standard programming is completed.

By confirming the \pm Exit step the device automatically returns to the usual displaying mode and the present tank content is shown.

Mount the device cover after completing the initial setup!

Programming examples

<p>Example 1 Cellar welded heating oil tank for 6000 L of heating oil, linear steel tank. Interior height 165 cm, (filling level: 125 cm), LITRO-level probe 0 - 250 mbar. Device e-litro:</p>		
	<p><u>Menu item</u></p> <ol style="list-style-type: none"> 1. Measuring probe 2. Liquid 3. Tank shape 4. Tank volume 5. Tank height 5b. Filling Limit 6. Display 7. Relay 8. Exit [Enter] 	<p><u>Setting / Selection</u></p> <p>250 mbar Heating oil Linear 6000 liter 165.0 cm 95% Fillspace + Level OFF Displaying mode => ... 4550 l ... 76 %</p>

Example 2 Buried tank, cylindric horizontal, for 10,000 liters diesel,
 Inner height 1.59 m, (filling level 54 cm), LITRO-level probe 0 - **250 mbar**
 Device **e-litro gsm** with SIM card:

<u>Menu item</u>	<u>Setting / Selection</u>
1. Measuring probe	250 mbar
2. Liquid	Diesel oil
3. Tank shape	Cylindric horizontal
4. Tank volume	10050 l (<u>exact value from bearing chart</u>)
5. Tank height	159.0 cm (<u>exact value from bearing chart</u>)
5b. Filling limit	99% (no limit indicator)
6. Display	Fillspace + Level
7. Relay	On: 96% Off: 94% (relay energizes at 96%)
8. (Exit)	Go forward to next step with [+]
...	...
15. Modem	PIN: xxxx - enter the PIN code of the SIM-card
...	...
19. Exit [Enter]	Displaying mode => ... 1280 l ... 13 %

Example 3 **e-litro secu4** device with 4 battery tanks 4 x 1250 liters,
 steel tanks with hemicycles at top and bottom, 155cm tank height,
 display: Fillspace + Level for each single tank
 disable tank filling at a limit of 94%.

<u>Menu item</u>	<u>Setting / Selection</u>
1. Number of tanks	4
2. Liquid	Heating oil
3. Tank shape	Steel tanks
4. Tank volume	1250 L (x 4)
5. Tank height	155.0 cm
5b. Filling limit	94% = 146cm
6. Display	Not available for secu4 (no function)
7. Unit	Active => on qat 99% ; off qat 10% of the filling level
8. Exit [Enter]	Back to displaying mode; Display 1 (details per tank) switches with Display 2 total inventory in L; filling space in L

Tank with interior mantle

In case of a tank with interior mantle (e.g. horz. cyl. or cellar steel tank) correct the input values.

Example: Mantle thickness: ca. 5 . 10 mm:
 => Enter ~~5~~.Tank heightq reduce height by ca. 15 mm
 => Enter ~~4~~.Tank volumeq reduce volume by ca. 2 %

Special settings

<u><i>Input function:</i></u> <u><i>Additional functions</i></u>	<u><i>Description</i></u>	<u><i>Device type</i></u>
Menu items 1 to 7 see pages 7-9	The menu items 1 to 7 are the basic setup of the devices. Some special settings, e.g. language, network parameters or others, have to be set up via menu items 9 to 24.	all
9. Offset probe or for <u>secu4</u> : 9. Exit	Sub-menu a. Offset calibration ±(electrical zero point) b. Probe bottom gap q (position over ground) c. Bottom dead stock q(shall not be displayed) - ESC Exit this sub-menu. - Offset calibration: Stores signal value of probe± zero point. Probe must not be plunged. - Probe bottom gap: Distance x cm Standard is x = 0 cm , max = 99 cm - Bottom deadstock: <u>Sucking</u> position over ground: y cm Standard is 0 cm = full inventory. y > 0 cm means dead stock height which doesn't occur in the liter displaying - Default values: Resets all values back to standard 0. For secu4: Exit	all do <u>not</u> execute with e-litro
10. Trim height	Input option for the reference height for calibration of probe and measurement device. It is useful in case of unknown specific weight of the fluid. Enter the current liquid level: xx.x cm (+ / - / Enter) and confirm with YES / no. If this is done at a low tank filling level it is recommend to repeat this later again at a higher filling level.	all
11. Exit	Exit the menu with [Enter].	all
12. Unit	Adjustable units are: L (liters), %, m, kg, t (tons), IG (Imperial Gallons), UG (US-Gallons) as well as pressure units mbar and kPa. [+ / - / Enter] ±qor ±gqvalues are displayed with a separator point for values over 1000. %qor %nqvalues are displayed with two decimal places.	not for <u>secu4</u>
13. Rounding	Automatically - Default setting for automatic rounding Without rounding - No rounding means highest resolution. Unsteady, wobbling values may occur. 2 / 5 / 10 / 20 / 50 / 100 [L] are selectable	not for <u>secu4</u>
14. Exit	Exit the menu with [Enter].	all

<p>15. Network</p> <p>or</p> <p>15. Modem</p>	<p>e-litro net :</p> <ul style="list-style-type: none"> - DHCP . . . <p>Sub-menu for network parameter setup like IP address, message destination and communication test. Please coordinate these settings with your network admin. See additional documentation network device connectionq</p> <p>e-litro gsm:</p> <ul style="list-style-type: none"> - Send SMS . . . <p>A test SMS will be sent to the mobile number set by #T command. See additional documentation Messages, commands a. parametersq</p> <ul style="list-style-type: none"> - PIN <p>Shows the PIN no. of the SIM card. PIN = 0000 completely deactivates the internal GSM modem.</p>	<p>only for e-litro net</p> <p>only for e-litro gsm</p>				
<p>16. Delete tank</p>	<p>ESCq/ tank nq</p> <p>Deletion of a registered tank. Here you may re-sort or delete the registered tank numbers. (+ / - / Return)</p>	<p>only for e-litro gsm e-litro net</p>				
<p>17.Input/Output</p>	<table border="1"> <tr> <td data-bbox="309 652 434 863"> <p>Alarm-In:</p> <p>...</p> </td> <td data-bbox="434 652 908 863"> <p>Choose the function of the alarm contact input:</p> <ul style="list-style-type: none"> - Deactive Defines the alarm input to be not operatingq - Opening If input contact opens for > 4 min. then alarm case will be entered. - Closing If input contact closes for > 4 min. then alarm case will be entered. </td> </tr> <tr> <td data-bbox="309 863 434 1086"> <p>Data-Out:</p> <p>...</p> </td> <td data-bbox="434 863 908 1086"> <p>Defines the data output at the adaptor slot. The available options are:</p> <ul style="list-style-type: none"> - Output of single tank data T1 / T2 / T3 / T4 => Applicable for analog adaptor. - Output of all tanks T1 . T4 => Data of all tanks sequentially go to the output, e.g. for a PC-LINK output adaptor. </td> </tr> </table>	<p>Alarm-In:</p> <p>...</p>	<p>Choose the function of the alarm contact input:</p> <ul style="list-style-type: none"> - Deactive Defines the alarm input to be not operatingq - Opening If input contact opens for > 4 min. then alarm case will be entered. - Closing If input contact closes for > 4 min. then alarm case will be entered. 	<p>Data-Out:</p> <p>...</p>	<p>Defines the data output at the adaptor slot. The available options are:</p> <ul style="list-style-type: none"> - Output of single tank data T1 / T2 / T3 / T4 => Applicable for analog adaptor. - Output of all tanks T1 . T4 => Data of all tanks sequentially go to the output, e.g. for a PC-LINK output adaptor. 	<p>only for e-litro gsm e-litro net</p> <p>only for e-litro gsm e-litro net</p>
<p>Alarm-In:</p> <p>...</p>	<p>Choose the function of the alarm contact input:</p> <ul style="list-style-type: none"> - Deactive Defines the alarm input to be not operatingq - Opening If input contact opens for > 4 min. then alarm case will be entered. - Closing If input contact closes for > 4 min. then alarm case will be entered. 					
<p>Data-Out:</p> <p>...</p>	<p>Defines the data output at the adaptor slot. The available options are:</p> <ul style="list-style-type: none"> - Output of single tank data T1 / T2 / T3 / T4 => Applicable for analog adaptor. - Output of all tanks T1 . T4 => Data of all tanks sequentially go to the output, e.g. for a PC-LINK output adaptor. 					
<p>18.Language + Names</p>	<table border="1"> <tr> <td data-bbox="309 1086 434 1161"> <p>Language:</p> <p>...</p> </td> <td data-bbox="434 1086 908 1161"> <p>Germanq/ Englishq/ Frenchq + / - / Enter</p> </td> </tr> <tr> <td data-bbox="309 1161 434 1254"> <p>Names:</p> <p>...</p> </td> <td data-bbox="434 1161 908 1254"> <p>Tank name: (Name suggestion:) Heating oil Choose letters with + / - / Enter</p> </td> </tr> </table>	<p>Language:</p> <p>...</p>	<p>Germanq/ Englishq/ Frenchq + / - / Enter</p>	<p>Names:</p> <p>...</p>	<p>Tank name: (Name suggestion:) Heating oil Choose letters with + / - / Enter</p>	<p>all</p> <p>all</p>
<p>Language:</p> <p>...</p>	<p>Germanq/ Englishq/ Frenchq + / - / Enter</p>					
<p>Names:</p> <p>...</p>	<p>Tank name: (Name suggestion:) Heating oil Choose letters with + / - / Enter</p>					
<p>19.Exit</p>	<p>Press [Enter] to return to the displaying mode.</p>	<p>all</p>				

<u>Input function:</u> <u>Additional functions</u>	<u>Description</u>	<u>Device type</u>
20. LCD Display	By factory the contrast of the LCD display is preset as: Contrast: xx (xx is a hexadecimal value)	all
21. Device-info	Shows: Software version : V6.01 (e.g.) Serial no. : Tank i: SN=1234 (i = Tank-no.) Offset + Gain : X0=2980 B=1268 (for Tank i)	all
22. Test current	Testing function for the current mA signal of the measuring probe: e.g. ADC = 28A0 = 4.00 mA If the bubbling-through pipe is not plunged the value should be near to 4 mA. Tolerance range is 3.7 ... 4.3 mA. If out of tolerance range see menu item 9.	Not for <u>secu4</u>
23. Test relay	Testing function for relay switching: Relay 1 = Off / On + / - / Enter	Not for e-litro
24. Reset	Resetting the device software: - ESC : Leaves this sub-menu without execution. - Restart : New initialization of the device software, but parameter setup is left unchanged. - Factory setting: Complete reset of all parameters back to the original factory settings.	all
25. Configuration	Protected area: Exit with: \pounds fg:0q [Enter]	all
26. Exit	Press [Enter] to return to the displaying mode.	all

Error messages / Error indication

Display: **wait...**

This notification indicates that the connected LITRO-Sensor or the sensorbox is still in power charging mode. It should disappear after 1 to max. 5 min. and the normal tank level should be displayed.

Normally the LITRO-Sensor indicates this status with a red-green parallel blinking. In case the display status remains unchanged for more than 10 min, please unplug the power plug for at least 10 sec.

Error code	Meaning
Error E 1	Invalid input value.
Error E 2	Signal value of the LITRO-sensor is too small (signal current less than 3.7 mA). In case of the secu4 the sensorbox transmits invalid data (probe error). Disconnect the current supply and turn the device back on. If the error lasts for at least 5 min. the LITRO-sensor or the sensorbox is defective.
Error E 3	Measuring value of the LITRO-sensor is too high for offset calibration. The probe must not be plunged! A current of 4.5 mA or higher indicates a probe problem.
Error E 4	Measured value is implausible. Perform menu item ⌘ .Offset probeq
Error E 5	Height input is larger than tank height. (Wrong input)
Error E 6	The measured value is too small for reference. Make sure the probe is plunged. The appointed height is too big or the measuring value (resp. the filling level) is too small for setting. Perform step ⌘ . Offset probeq Otherwise probe error.
Error E 7	The measured value is too small for the appointed tank height or tank volume. Make sure the probe is plunged!
Error E 8	For secu4: The high test pressure during the <u>maintenance check</u> (s. page 20) was fully reached. This was the aim of the test. <u>So no error is present.</u> For LITRO-sensor: Wait until the loading phase after the initial start is completed (max. 5min.). Otherwise the sensor is not connected properly. Plus (= blue or white or red) => connect to clamp 1. The second display line shows the signal current. A value larger than 22 mA (e.g. 25 mA) indicates a clogged or bent measurement line to the buried tank. Please blow through or replace the measurement line, preferably with the blue bubbling-through pipe of the e-litro set. As a TEST the bubbling-through pipe can be disconnected from the LITRO-Sensor. E8 should disappear with the next pumping action. Otherwise the LITRO-sensor is defective or it has too much pressure.
Error E 9	The current value is 0 mA. The probeq connection could be broken. Check probe connection (polarity) and extension and if necessary reconnect it.
Error E10	Calibration error. Switch off and on the 230V supply voltage after waiting for 5 sec and retry. Otherwise the LITRO-sensor or the sensorbox is defective.
Error E11	Warning: The liquid level of the tank is too low for an exact calibration (Press [Enter] to continue anyway).
Error E12	No measurement data is received yet from the external tanks 2, 3 or 4. In case of secu4 the sensorbox has not sent any data yet. Wait for 3 min.
Error E13	No measurable pump pressure. Disconnect the current supply then reconnect it and wait for one pumping cycle. If the error E13 remains the micro pump is defective. Otherwise <u>send in</u> the LITRO-sensor or the sensorbox! The device is not repairable on site. <u>Do not open</u> the device, loss of warranty!
Error E14	Charging voltage is too low. Wait for 3 min. If necessary disconnect the power supply for 10s.
Error E15	No data from the sensorbox. Potential disruption of the signal line to the sensorbox.
Error E16	Implausible pressure drop of one of the tank measuring lines (please check!). Disconnect the power supply for 10s or <u>cancel E16 with OK.</u> Otherwise the sensorbox is defective.
Error E18	Device function error. The internal test pressure was not reached! The sensorbox of the secu4 or the LITRO-sensor <u>has to</u> be replaced.

For device type **e-litro net**

Info/Error-Messages at Network Communication

Error N 1	No network communication. Problem with the internal network module. The device automatically executes a <code>qesetq</code> for the internal network module and retries communicating. Try disconnecting the power supply, wait <code>õ</code> and reconnect.
Error N 2	Error in the network communication. Signal destination cannot be reached / data sending impossible. Check the connections at the device and at the network router. Check parameter setup at menu item <code>45.Networkq..</code> Perform the function <code>q5.Network > Test > Ping: Yesqõ</code> Try to connect a different network device at this network cable, e.g. a Laptop. If it does not work please contact your network administrator. Error N2 only occurs in case of a domain like <code>silview.deqis</code> entered for destination. In case of entering an individual dest-IP, no Error N2 message will be shown. Important: The destination address must be a <u>fixed</u> IP address. Otherwise the device retries sending again and again, caused by an unreachable destination IP address.
Sending ...	<code>qendingqis</code> displayed if a data message is currently in process of sending. The message destination can be setup as an IP address at menu item <code>45.Network => Dest. ...q</code> <code>qending...q</code> will be displayed periodically caused by an unreachable destination IP. The destination should be a fixed IP address. IP + Port should be set correctly.

XML-Data:	Call the device via browser or program with command <i>IP-address / xml</i>
------------------	--

Relay remote control:

Telecontrol / Teleswitching via relay of the **e-litro net** device:

The relay can be operated by remote commands from the browser at the `onfigqpage`.

Please refer to the additional device parametrization.



Deactive = No switching

Active = State depends on level

On = Makes the relay operate (fix)

Off = Makes the relay release state (fix)

For device type **e-litro gsm**

Error messages GSM module / SIM card / Mobile network

Error M 0	GSM modem is inactive. Entering PIN => 0000 completely deactivates the modem.
Error M 1	Internal communication error. The device automatically executes an internal RESET and retries communicating with the internal modem.
Error M 2	SIM card is not inserted, is not readable or is defective. Please check the SIM card using a mobile phone.
Error M 3	PUK code must be entered. Wrong PIN has been entered three times, SIM-card is locked. Insert the SIM card in a mobile phone and enter the PUK code to unlock it.
Error M 4	No credit on the prepaid account.
Error M 5	No mobile network available for the SIM card (an external antenna could help). Destination number set correctly? (please check)
Error M 6	Network or other failure during sending procedure.
Error M 7	Mobile network registration not completed yet.
Error M 8	Interlock is active! In case of too many failed network logins after 7 days only 1 dial-in trial will be performed on a daily basis for 255 days maximum. The [Enter] button activates the device for another logon trial. In case of a successful sending the interlock will be removed.
Error M 9	No destination mobile number configured yet. #T command or OilView-connection not configured yet.

Relay-remote control:	Telecontrol / Teleswitching via relay of the e-litro gsm device: The relay can be operated by #S-commands. Please refer to the additional device parametrization.
------------------------------	--

Electrical connections for e-litro



= slot for adaptors:
M-BUS ; 0-5 V outlet ;
4-20 mA outlet ; link adaptor

Clamp contact number:

- 1: LITRO-sensor input (+)
(red or white or blue)
- 2: LITRO-sensor input () (brown or black)
- 3 + 4: Input for a second LITRO-sensor
(this option is not equipped)



Rightmost clamping block: AC 230V N/L supply

Electrical connections for secu4

Left clamping block:

Sensorbox connection

- [1] = white (plus)
- [2] = green (signal)
- [3] = brown (minus)

Bottom right clamping block:

Power supply: 230V AC N/L



Electrical connections for e-litro net / e-litro gsm



Clamp contact number:

- 1: LITRO-Sensor input (+) (red, white, blue)
- 2: ditto () (black, brown)
- 3: data input for additional e-litro device (+)
- 4: ditto ()
- 5: alarming contact input (+)
- 6: ditto ()
- 7 + 8: relay output: opening contact (normal status is closed)
- 9 + 10: relay output: closing contact (normal status is open)

Rightmost clamping block: AC 230V N/L supply

Regulations, Maintenance and Documentation

Regulations:



- Installation and startup have to be performed by a qualified technician.
- The regulations of the device documentation have to be followed precisely. The documentation needs to be preserved at the device.
- The device settings are to be performed accurately for all parameters. The device parameters will be set by a qualified technician once and will be checked at maintenance.
- During a refill the display warning and alarm signaling need to be observed carefully by the responsible person (tanker truck driver)! In case of an alarm the refill needs to be stopped immediately!
- In displaying mode the device is unmanned. Accordingly the device has no adjustment options accessible from the outside. Only an alarm-QUIT-button is located at the top of the device.
- The unit functions should be checked regularly e.g. during the boiler maintenance. This needs to be induced by the operator.
- If the **secu4is** tanker switch off function is used the password needs to be activated in menu item 8. The password is predefined.

Password for **secu4**:

Maintenance:



- Manufacturer's specification: Perform hardware maintenance at every tank or boiler maintenance. After expiration of the warranty period perform maintenance 1 x per year.
- Check the relay switching function via menu item \varnothing 3 Test relayq
- For the measurement value test the filling level of the tank needs to be determined and compared to the displayed value (cm). Valid measurement variation \leq 2% of a full tank.
- **Additionally for secu4:**
Fold and hold the measurement hose of tank 1 until the sensorbox has completed its pumping process
Check: Then the display has to show Error **E008**, by means the test was successful (OK).
Otherwise the check was **not** successful! In that case please send in the sensorbox to TECSON to be repaired.

Producer:

TECSON GmbH & Co. KG
Wulfsfelder Weg 2a
D-24242 Felde

Tel. (+49) 4340 / 402530
Fax (+49) 4340 / 402529
www.tecson.de / info@tecson.de



The producer conformity certificate is located at
www.tecson.de under menu item \varnothing Documentationq